

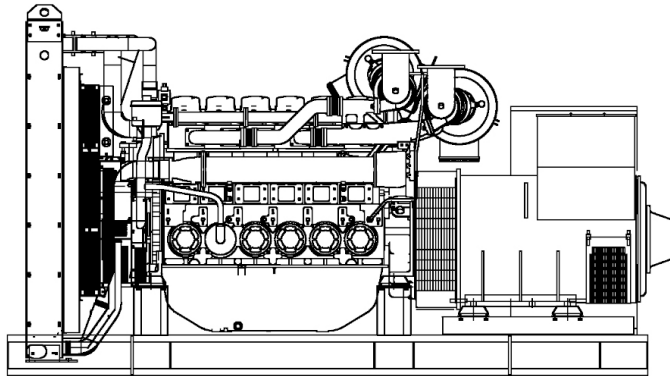

POWERFULL "U"



For illustrative purposes only

ENGINE

Description	PERKINS
Engine model	4006-23TAG3A
Cylinders	6
RPM speed	1500
Cubic capacity	22.92 l
Air intake	Turbocharged
Standard voltage	24 Vdc
Optional voltage	Vdc
Sae	0-18
BMEP	2452 kPa
Cooling	Water
Flywheel P.R.P. Power net	675.0 kW
Flywheel E.P. Power net	756.0 kW
Fuel Cons. at 100% (E.P.)	194.0 l/h
Fuel Cons. at 100% (P.R.P.)	172.0 l/h
Fuel Cons. at 75% (P.R.P.)	130.0 l/h
Fuel Cons. at 50% (P.R.P.)	90.0 l/h
Fuel Cons. at 25% (P.R.P.)	0.0 l/h
Electronic regulator	Standard
Precision class	G3
Oil quantity	122.7 l
Engine Antifreeze capacity	51.0 l
Radiator type	TR
Heat from radiator	541.0 kW
Heat from exhaust	741.0 kW
Heat from radiation	86.0 kW
Exhaust temperature	500 °C
Portata Raffreddamento	870.0 m ³ /min
Combustion air flow	73.0 m ³ /min
Exhaust gas flow	193.0 m ³ /min
TA Luft	N
TA Luft/2	N
EPA	N
Stage	N

MAIN DATA

Continuous power (PRP)	800.00 kVA
Continuous power (PRP)	640.00 kW
Emergency power (E.P.)	900.00 kVA
Emergency power (E.P.)	720.00 kW
VAC - HZ - cos(fi)	415 - 50 - 0.8

DIMENSIONS AND WEIGHT

Width	2100 mm
Length	4000 mm
Height	2100 mm
Weight	6290 kg

ALTERNATOR

Description	STAMFORD
Alternator model	S6L1D-D
P.R.P. Power	940.0 kVA
E.P. Power	1010.0 kVA
Connection	Star
Phases	3FN
Winding	312
Terminal Number	6 nr.
IP Protection	23
Electronic regulator	MX322
Precision	0.5 ± %

BASEFRAME

Model	ST60
Standard tank	0 l
Optional tank	0 l
Oversized tank*	0 l

CANOPY & SILENCER

Canopy model	SENZA COFANO
Silencer model	MS 35
Silencer outlet diameter	168.0 mm

Standard reference conditions temperature 25°C, altitude 100m asl, relative humidity 30%, atmospheric pressure 100 kPa (1 bar), power factor 0.8 lag, balanced load - non distortional. Fuel consumption is nominal and refers to specific weight 0.850kg/l. Sound power values refer to free field conditions: the installation site may influence the values. Dimensions, weights and other specifications contained in the technical data sheet and related attachments are nominal, subject to tolerances and refer to the model with standard equipment; any optional and additional equipment/accessories can modify weight, dimensions, performance. **P.R.P. - Prime Power-Continuous power at variable load:** The power that a genset can supply in continuous service at a variable load for an unlimited number of hours per year while respecting the maintenance intervals established in the environmental conditions stated by the Manufacturer, according to ISO8528-1. The average power supplied over time and any applicable overload must be less than the percentages stated by the Manufacturer. **E.P. - Emergency power:** This is the maximum power that a generating set can deliver for a limited number of hours per year while complying with the maintenance frequency stipulated under the environmental conditions set by the Manufacturer. The number of hours per year is determined by the engine manufacturer. The average power output over time must be lower than the percentages set by the engine manufacturer. Overloading is not allowed.

The data contained in this document is nominal and refers to the standard equipped model and is not binding. Visa S.p.A. reserves the right to revise the information without notice per our policy of continuous product development and improvement.

