

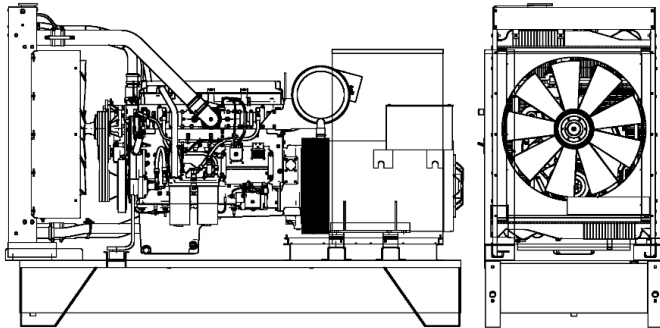

POWERFULL "B"



For illustrative purposes only

ENGINE

Description	VOLVO-PENTA
Engine model	TWD1644GE
Cylinders	6
RPM speed	1800
Cubic capacity	16.12 l
Air intake	Turbocharged
Standard voltage	24 Vdc
Optional voltage	Vdc
Sae	1-14
BMEP	2550 kPa
Cooling	Water
Flywheel P.R.P. Power net	582.0 kW
Flywheel E.P. Power net	640.0 kW
Fuel Cons. at 100% (E.P.)	158.9 l/h
Fuel Cons. at 100% (P.R.P.)	145.9 l/h
Fuel Cons. at 75% (P.R.P.)	109.5 l/h
Fuel Cons. at 50% (P.R.P.)	74.8 l/h
Fuel Cons. at 25% (P.R.P.)	43.1 l/h
Electronic regulator	Standard
Precision class	G3
Oil quantity	48.0 l
Engine Antifreeze capacity	25.0 l
Radiator type	TR
Heat from radiator	393.0 kW
Heat from exhaust	495.0 kW
Heat from radiation	24.0 kW
Exhaust temperature	495 °C
Portata Raffreddamento	738.0 m ³ /min
Combustion air flow	46.7 m ³ /min
Exhaust gas flow	114.5 m ³ /min
TA Luft	N
TA Luft/2	N
EPA	N
Stage	N

MAIN DATA

Continuous power (PRP)	685.00 kVA
Continuous power (PRP)	548.00 kW
Emergency power (E.P.)	750.00 kVA
Emergency power (E.P.)	600.00 kW
VAC - HZ - cos(fi)	220 - 60 - 0.8

DIMENSIONS AND WEIGHT

Width	1350 mm
Length	3530 mm
Height	2300 mm
Weight	4550 kg

ALTERNATOR

Description	STAMFORD
Alternator model	HC15F
P.R.P. Power	775.0 kVA
E.P. Power	844.0 kVA
Connection	Parallel star
Phases	3FN
Winding	311
Terminal Number	12 nr.
IP Protection	23
Electronic regulator	AS440
Precision	1.0 ± %

BASEFRAME

Model	T3
Standard tank	900 l
Optional tank	0 l
Oversized tank*	0 l

CANOPY & SILENCER

Canopy model	SENZA COFANO
Silencer model	MS 35
Silencer outlet diameter	168.0 mm

Standard reference conditions temperature 25°C, altitude 100m asl, relative humidity 30%, atmospheric pressure 100 kPa (1 bar), power factor 0.8 lag, balanced load - non distortional. Fuel consumption is nominal and refers to specific weight 0.850kg/l. Sound power values refer to free field conditions: the installation site may influence the values. Dimensions, weights and other specifications contained in the technical data sheet and related attachments are nominal, subject to tolerances and refer to the model with standard equipment; any optional and additional equipment/accessories can modify weight, dimensions, performance. **P.R.P. - Prime Power-Continuous power at variable load:** The power that a genset can supply in continuous service at a variable load for an unlimited number of hours per year while respecting the maintenance intervals established in the environmental conditions stated by the Manufacturer, according to ISO8528-1. The average power supplied over time and any applicable overload must be less than the percentages stated by the Manufacturer. **E.P. - Emergency power:** This is the maximum power that a generating set can deliver for a limited number of hours per year while complying with the maintenance frequency stipulated under the environmental conditions set by the Manufacturer. The number of hours per year is determined by the engine manufacturer. The average power output over time must be lower than the percentages set by the engine manufacturer. Overloading is not allowed.

The data contained in this document is nominal and refers to the standard equipped model and is not binding. Visa S.p.A. reserves the right to revise the information without notice per our policy of continuous product development and improvement.

